

DRAWERED SANDWICH PREP. TABLES

Back Mounted Condensing Unit



EVEREST
REFRIGERATION
www.EVERESTref.com

EPBN – Series

- EPBNR1-D2 • EPBNSR2-D2
- EPBNR2-D4 • EPBNWR2-D4 • EPBNR3-D2



EPBNR1-D2



EPBNSR2-D2



EPBNR2-D4



EPBNWR2-D4



EPBNR3-D2

Cabinet Construction

Heavy duty stainless steel interior and exterior, galvanized steel finished bottom and back wall of exterior. High quality 16 gauge stainless steel worktop, top lid and hood. 2.5" thick high density foamed-in-place polyurethane insulation. Four 4" diameter casters (front casters with brakes). Door and drawer heater installed around inside cabinet frame to prevent moisture build-up.

Refrigeration System

- Back mounted condensing unit
- Oversized condenser and evaporator coils quickly achieve and maintain desired temperature
- Forced-air cooling with oversized evaporator fan motors providing balanced airflow throughout cabinet to ensure faster temperature drop
- Slide-out condensing unit for convenient repair and maintenance
- Front air breathing for built-in applications
- Environmentally friendly CFC free R-134A refrigerant
- Air defrost controlled by electrical timer
- Copper tube and aluminum fin evaporator with anti-corrosive coating
- Energy efficient condensate drain pan assembly heated by high side copper tube
- Pressure relief port for rapid cabinet re-entry
- Pre-wired and ready to plug, 115V/60Hz/1Ph, NEMA 5-15P

Doors & Drawers

- Heavy duty stainless steel interior and exterior
- 2.5" thick high density foamed-in-place polyurethane insulation
- Heavy duty adjustable torsion spring self-closing door system
- One piece snap-in magnetic door and drawer gaskets for easy replacement
- Heavy duty recessed door and drawer handles for a flat surface
- Heavy duty 304 stainless steel drawer frames with low-friction ball bearing slides
(Note: refer to the website for pan configurations)

Preparation Area

- 1/2" thick foam insulated lids to prevent moisture build-up and heat exchange
- Removable and adjustable sanitary 12 1/4" deep cutting board
- Sanitary polycarbonate pans

Shelving (Model EPBNR3-D2)

- One epoxy coated wire shelf
- Stainless steel pilasters and shelf clips

Temperature Control

- Factory preset temperature, 35°F
- Temperature setting range from 32°F to 42°F
- Easy to set analog thermostat

• Project / Customer _____

• Item No. _____

• Model No. _____

Warranty

5 Year — Compressor Warranty
3 Year — Parts & Labor Warranty
Applicable to units purchased after July 1, 2014.

Contact

201 W. Artesia Blvd, Compton, CA 90220
T. (310) 323-6586, (800) 444-6285
F. (310) 323-7524, (310) 761-1127

DRAWERED SANDWICH PREP TABLES

Back Mounted Condensing Unit



EPBN – Series

- EPBNR1-D2 • EPBNSR2-D2
- EPBNR2-D4 • EPBNWR2-D4 • EPBNR3-D2

Dimensions

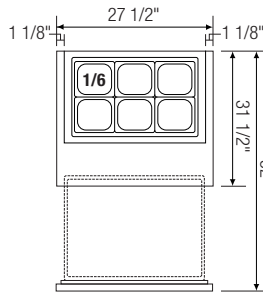
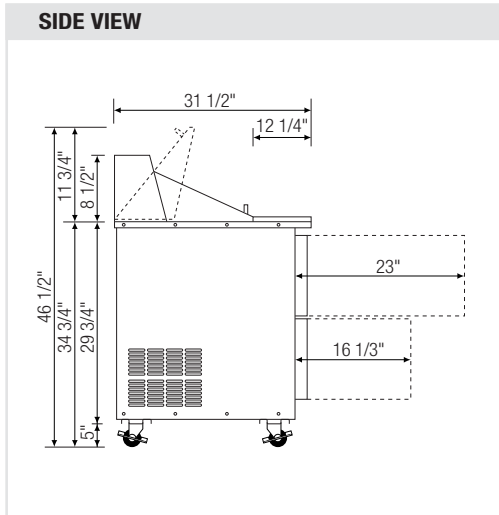

▲ EPBNR1-D2

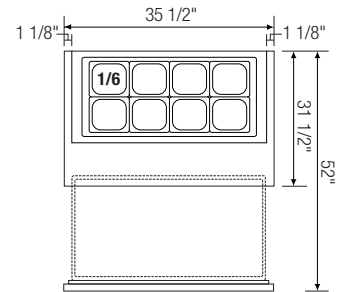

▲ EPBNSR2-D2

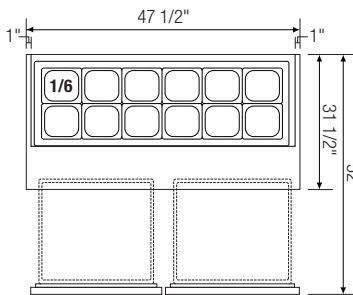
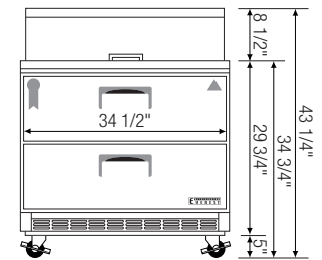
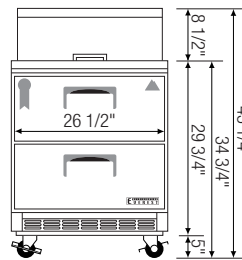

▲ EPBNR2-D4

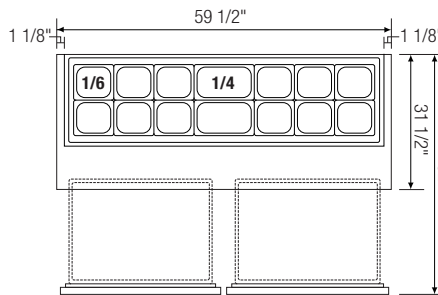

▲ EPBNWR2-D4

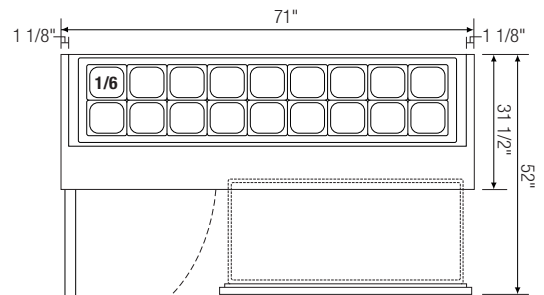

▲ EPBNR3-D2

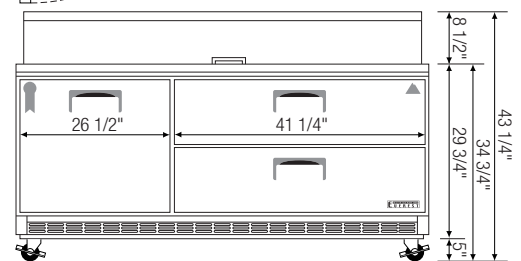
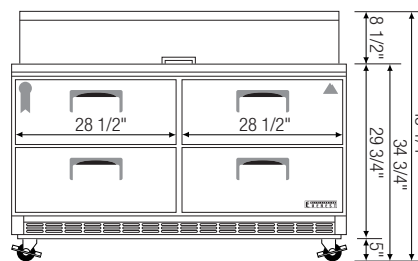
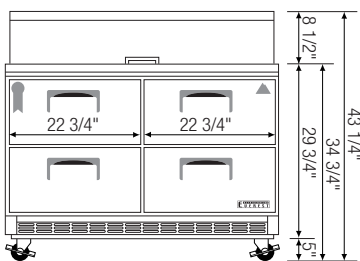

Model	Ref/ Frz/ Dual	# of Doors & Drawers	Capacity (Cu.Ft.)	HP	Refrigerant	# of Shelves	# of Pans (Top)	# of Pans † (Drawer)	Power (V-Hz-Ph)	Amps	Crated Weight (LBS)	Exterior Dimensions (Inches)			* Height does not include 5" for casters † Drawer pans are not included
												L	D	H *	
EPBNR1-D2	Ref	2(DR)	6.5	1/6	R-134A	N/A	1/6 X 6	1/2 x 4 1/4 x 2	115-60-1	4.00	242	27 1/2	31 1/2	38 1/4	
EPBNSR2-D2	Ref	2(DR)	8.5	1/6	R-134A	N/A	1/6 X 8	1/2 x 4, 1/3 x 1 1/4 x 2, 1/6 x 1	115-60-1	4.20	282	35 1/2	31 1/2	38 1/4	Ref = Refrigerator Frz = Freezer
EPBNR2-D4	Ref	4(DR)	11.8	1/4	R-134A	N/A	1/6 X 12	1/2 x 4, 1/3 x 4 1/4 x 2, 1/6 x 2	115-60-1	4.20	364	47 1/2	31 1/2	38 1/4	D = Door DR = Drawer
EPBNWR2-D4	Ref	4(DR)	15	1/3	R-134A	N/A	1/6 X 12 1/4 X 2	1/2 x 4, 1/3 x 8 1/4 x 2, 1/6 x 4	115-60-1	5.01	421	59 1/2	31 1/2	38 1/4	
EPBNR3-D2	Ref	1(D) 2(DR)	18.3	1/3	R-134A	1	1/6 X 18	1/2 x 2, 1/3 x 8 1/4 x 1, 1/6 x 4	115-60-1	5.20	466	71	31 1/2	38 1/4	

Disclaimer: Product dimensions are for general purposes and not absolute value. Slight variations may exist. If dimensions are critical, please contact Everest.