

GLASS DOOR MERCHANDISER REFRIGERATORS

Multiple Swing Doors



EVEREST
REFRIGERATION

www.EVERESTref.com

EM – Series

• EMSGR33 • EMSGR48 • EMSGR69



EMSGR33



EMSGR48



EMSGR69

Cabinet Construction

Heavy duty white coated steel for cabinet interior and exterior. High quality stainless steel interior floor with round edges for convenient cleaning. White coated aluminum drain pan. 2.5" thick high density foamed-in-place polyurethane insulation. Adjustable screw legs for leveling. One additional heavy duty adjustable screw leg located at bottom of front cabinet for weight support for model EMSGR69.

Refrigeration System

- Bottom mounted condensing unit
- Removable bottom grill and slide-out condensing unit for easy repair and maintenance
- Oversized condenser and evaporator coils quickly achieve and maintain desired temperature
- Forced-air cooling with oversized evaporator fan motors providing balanced airflow throughout cabinet to ensure faster temperature drop
- Environmentally friendly CFC free R-134A refrigerant
- Air defrost controlled by thermostat
- Copper tube and aluminum fin evaporator with anti-corrosive coating
- Energy efficient condensate drain pan with wicking pads for self sufficient condensation removal
- Pre-wired and ready to plug, 115V/60Hz/1Ph, NEMA 5-15P

Doors

- Black PVC door frames
- Low emissivity double pane glass system reflects UV rays and improves insulation for maximized energy efficiency
- Heavy duty adjustable torsion spring self-closing door system
- One piece snap-in magnetic door gasket for easy replacement
- Heavy duty die-cast door handles

Lighting

- Shielded vertical LED interior lighting with on/off switch for energy saving, less heat generation and enhanced illumination (available from 2015 models)

Shelving

- Four epoxy coated wire shelves per section
- Stainless steel pilasters and shelf clips

Temperature Control

- Factory preset temperature, 35°F
- Temperature setting range from 32°F to 42°F
- Easy to set thermostat dial

Options

- 2 1/2" and 4" diameter casters (3 1/2" and 5" overall height)

• Project / Customer _____

• Item No. _____

• Model No. _____

Warranty

 **5 Year — Compressor Warranty**
3 Year — Parts & Labor Warranty
Applicable to units purchased after July 1, 2014.

Contact

 201 W. Artesia Blvd, Compton, CA 90220
T. (310) 323-6586, (800) 444-6285
F. (310) 323-7524, (310) 761-1127

GLASS DOOR MERCHANDISER REFRIGERATORS

Multiple Swing Doors



EVEREST
REFRIGERATION
www.EVERESTref.com

EM – Series • EMSGR33 • EMSGR48 • EMSGR69

Dimensions

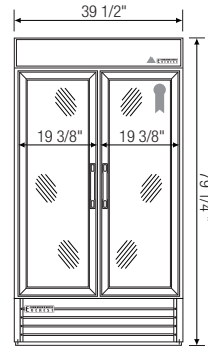
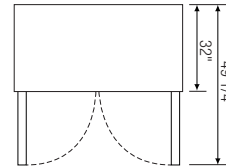
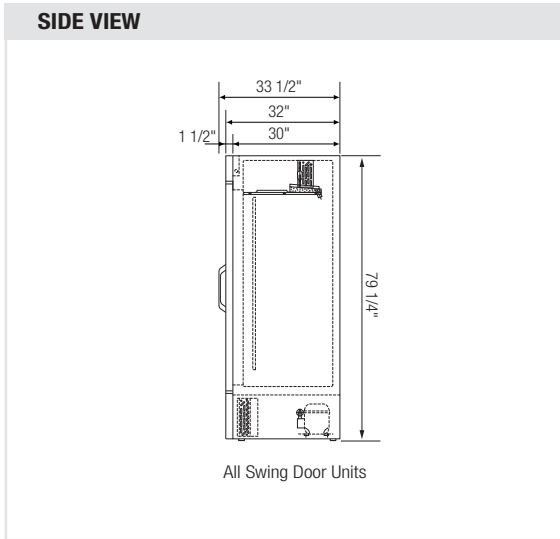

▲ EMSGR33

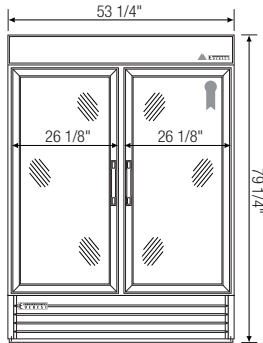
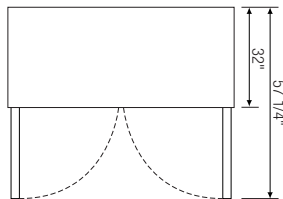

▲ EMSGR48

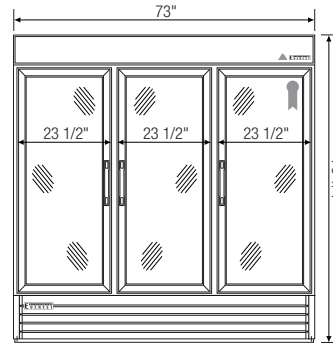
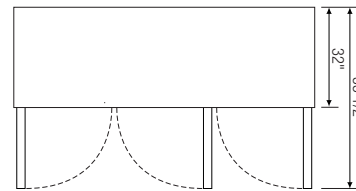

▲ EMSGR69

Model	Ref/ Frz/ Dual	# of Doors	Capacity (Cu.Ft.)	HP	Refrigerant	# of Shelves	Capacity 20 oz. Bottles	Power (V-Hz-Ph)	Amps	Crated Weight (LBS)	Exterior Dimensions (Inches)			* Exterior depth dimension does not include 1 1/2" for door handles
											L	D*	H	
EMSGR33	Ref	2(Swing)	33	1/3	R-134A	8	336	115-60-1	4.16	414	39 1/2	32	79 1/4	Ref = Refrigerator Frz = Freezer Dual = Ref & Frz Combo
EMSGR48	Ref	2(Swing)	48	1/2+	R-134A	8	448	115-60-1	9.00	533	53 1/4	32	79 1/4	
EMSGR69	Ref	3(Swing)	69	3/4+	R-134A	12	672	115-60-1	11.00	698	73	32	79 1/4	

Disclaimer: Product dimensions are for general purposes and not absolute value. Slight variations may exist. If dimensions are critical, please contact Everest.