

HORIZONTAL BOTTLE COOLERS



EBC – Series

- EBC37 • EBC50 • EBC65 • EBC80 • EBC95



EBC37



EBC50



EBC65



EBC80



EBC95

Cabinet Construction

Heavy duty stainless steel countertop, rail and lids, with textured and laminated black vinyl exterior. Galvanized steel interior. 1 3/4" thick high density foamed-in-place polyurethane insulation. Built-in caster thread receptacles for all units.

Refrigeration System

- Side mounted condensing unit
- Oversized condenser and evaporator coils quickly achieve and maintain desired temperature
- Forced-air cooling with oversized evaporator fan motors providing balanced airflow throughout cabinet to ensure faster temperature drop
- Removable side panel and slide-out condensing unit for convenient repair and maintenance
- Environmentally friendly CFC free R-134A refrigerant
- Air defrost controlled by electrical timer
- Copper tube and aluminum fin evaporator with anti-corrosive coating
- Energy efficient condensate drain pan assembly heated by high side copper tube
- Pre-wired and ready to plug, 115V/60Hz/1Ph, NEMA 5-15P

Lids, Locks, Openers

- Heavy duty stainless steel, easy glide and removable lids
- 3/4" thick lids, foamed-in-place polyurethane insulation
- Ratchet locks to secure lids (standard)
- Removable bottle cap opener and cap catcher

Shelving

- Epoxy coated floor wire shelves for cold air circulation
- Adjustable epoxy coated wire bin dividers

Temperature Control

- Factory preset temperature, 35°F
- Temperature setting range from 32°F to 42°F
- Easy to set analog thermostat

Options

- 2 1/2" and 4" diameter casters (3 1/2" and 5" overall height)

• Project / Customer _____

• Item No. _____

• Model No. _____



Warranty

 **5 Year — Compressor Warranty**
3 Year — Parts & Labor Warranty
Applicable to units purchased after July 1, 2014.

Contact

 201 W. Artesia Blvd, Compton, CA 90220
T. (310) 323-6586, (800) 444-6285
F. (310) 323-7524, (310) 761-1127

HORIZONTAL BOTTLE COOLERS



EBC-Series

• EBC37 • EBC50 • EBC65 • EBC80 • EBC95

Dimensions

SIDE VIEW

★ 3/4" O.D.

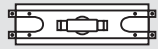

T-Shaped PVC
Drain Fittings w/
Movable Plug

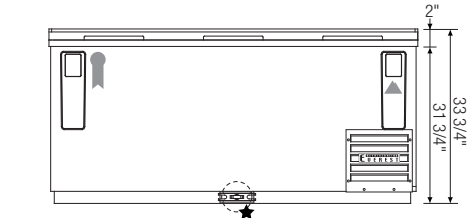
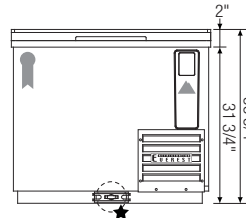
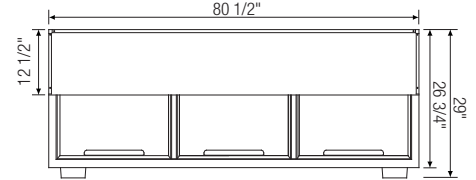
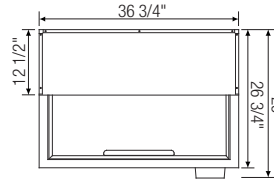
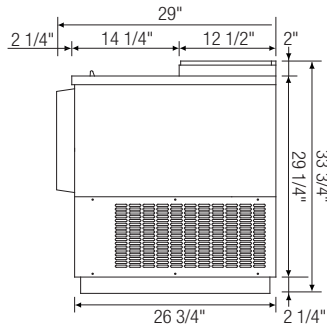

▲ EBC37

▲ EBC80

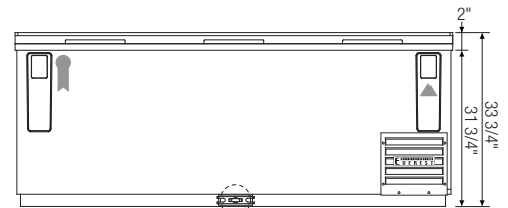
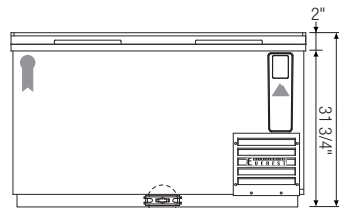
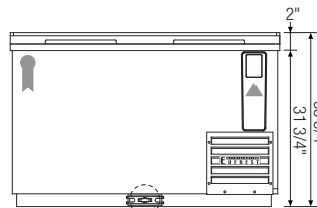
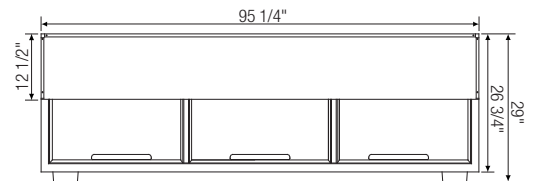
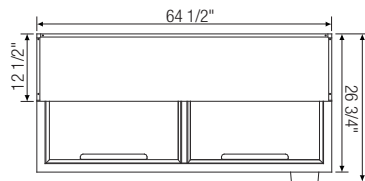
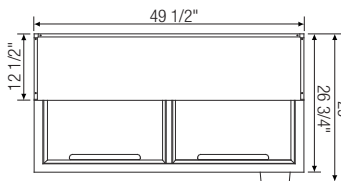

▲ EBC50

▲ EBC65

▲ EBC95

Model	Ref/ Frz/ Dual	# of Lids	Capacity (Cu.Ft.)	HP	Refrigerant	# of Bin Dividers	# of Shelves	Capacity		Power (V-Hz-Ph)	Amps	Crated Weight (LBS)	Exterior Dimensions (Inches)			* Depth does not include bottle cap opener with integrated cap receptacle
								12 oz. Cans	12 oz. Bottles				L	D*	H	
EBC37	Ref	1	9.30	1/4	R-134A	2	1	348	264	115-60-1	4.20	203	36 3/4	26 3/4	33 3/4	Ref = Refrigerator Frz = Freezer Dual = Ref & Frz Combo
EBC50	Ref	2	13.60	1/4	R-134A	3	2	576	396	115-60-1	4.20	245	49 1/2	26 3/4	33 3/4	
EBC65	Ref	2	18.90	1/4	R-134A	4	2	780	528	115-60-1	4.20	282	64 1/2	26 3/4	33 3/4	
EBC80	Ref	3	24.40	1/3	R-134A	5	3	1,008	720	115-60-1	5.40	333	80 1/2	26 3/4	33 3/4	
EBC95	Ref	3	29.60	1/3	R-134A	6	3	1,320	900	115-60-1	5.40	428	95 1/2	26 3/4	33 3/4	

Disclaimer: Product dimensions are for general purposes and not absolute value. Slight variations may exist. If dimensions are critical, please contact Everest.